

COMO C

MANUALLY OPERATED CHANGEOVER SWITCHES



COMO C are manually operated multipolar changeover switches. They changeover between two low voltage power circuits under load and provide safety disconnection.

Application: NORMAL/EMERGENCY

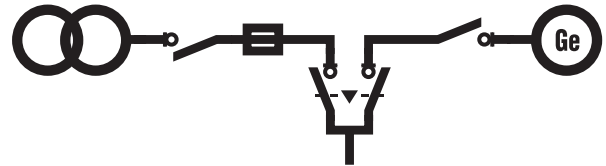

Application: UPS, SPEED VARIATOR

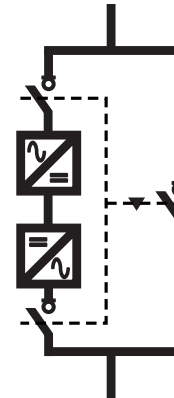

HIGHLIGHTS:

- Finger Safe
- Compact footprint
- Internal bridging link provided as standard
- Fully visualized breaking
- Large number of mounting possibilities (DIN rail, backplate or door mounting)
- Large number of configurations (I-II, I-0-II, I-0-II by-pass, I-I+II-II)
- Choice of external and direct handles

APPLICATIONS:

- Manual changeover from main supply to back-up source
- Switching between loads (motor or back-up)
- Reversing motor via phase inversion
- By-pass (upstream and downstream isolation in one operation)
- Earthing switch

Ratings

- 25, 40, 63, 80, 100 and 125 amperes

Approvals

- 25, 40, 63, 80, 100, 125 A
UL508 Manual Motor Controller
- IEC 60947-3
- NF EN 60947-3
- VDE 0660 Teil 107 (1992)



COMO C

MANUALLY OPERATED CHANGEOVER SWITCHES

COMO C RANGE: Changeover Switches from 25 to 125 Amperes



SELECT A SWITCH

AMPERE RATING	25	40	63
---------------	----	----	----

COMO C FOR I-II OPERATION

CATALOG NUMBER: 3 POLE
CATALOG NUMBER: 4 POLE

4220 3002	4220 3004	4220 3006
4220 4002	4220 4004	4220 4006

COMO C FOR I-0-II OPERATION

CATALOG NUMBER: 3 POLE
CATALOG NUMBER: 4 POLE

4230 3002	4230 3004	4230 3006
4230 4002	4230 4004	4230 4006

COMO C FOR I-0-II BY-PASS OPERATION

CATALOG NUMBER: 3 + 6 POLE
CATALOG NUMBER: 4 + 8 POLE

4250 3002	4250 3004	4250 3006
4250 4002	4250 4004	4250 4006

COMO C FOR I-I+II-II OPERATION (OVERLAPPING)

CATALOG NUMBER: 3 POLE
CATALOG NUMBER: 4 POLE

4240 3002	4240 3004	4240 3006
4240 4002	4240 4004	4240 4006



SELECT A SWITCH

COMO C FOR I-0-II OPERATION WITH ONE AUXILIARY CONTACT

CATALOG NUMBER: 3 POLE
CATALOG NUMBER: 4 POLE

4230 3102	4230 3104	4230 3106
4230 4102	4230 4104	4230 4106

COMO C FOR I-0-II OPERATION WITH TWO AUXILIARY CONTACTS

CATALOG NUMBER: 3 POLE
CATALOG NUMBER: 4 POLE

4230 3202	4230 3204	4230 3206
4230 4202	4230 4204	4230 4206

EXTERNAL AND DIRECT OPERATION



SELECT A HANDLE

TO SUIT SWITCH	PADLOCK POSITION	IP RATING	COLOR	CATALOG NUMBER		
I-II	I-II	IP54	Black/Grey	4259 1042	4259 1042	4259 1082
I-II	I-II	IP54	Red/Yellow	4259 1043	4259 1043	4259 1083
I-0-II / By-pass	0	IP54	Black/Grey	4259 1042	4259 1042	4259 1082
I-0-II / By-pass	0	IP54	Red/Yellow	4259 1043	4259 1043	4259 1083
I-I+II-II	I-I+II-II	IP54	Black/Grey	4259 1042	4259 1042	4259 1082
I-I+II-II	I-I+II-II	IP54	Red/Yellow	4259 1043	4259 1043	4259 1083
I-II	—	IP54	White	4259 2022	4259 2042	4259 2082
I-0-II / By-pass	—	IP54	White	4259 3022	4259 3042	4259 3082
I-I+II-II	—	IP54	White	4259 4022	4259 4042	4259 4082

FOR EXTERNAL OPERATION ONLY



SELECT A SHAFT

SHAFT LENGTH (inches/mm)	CATALOG NUMBER		
7.9/200	4259 5042 ⁽¹⁾	4259 5042 ⁽¹⁾	4259 5082 ⁽¹⁾



OPTIONS FOR I-II / I-0-II / BY-PASS / I-I+II-II CHANGEOVER SWITCHES

	CATALOG NUMBER		
Back plate mounting device	4259 9040	4259 9040	4259 9080
DIN rail mounting device	4259 9001	4259 9001	4259 9001

(1) Includes an escutcheon allowing the function of door interlocking in ON position

COMO C

MANUALLY OPERATED CHANGEOVER SWITCHES



SELECT A SWITCH

AMPERE RATING	80	100	125
---------------	----	-----	-----

COMO C FOR I-II OPERATION

CATALOG NUMBER: 3 POLE
CATALOG NUMBER: 4 POLE

4220 3008	4220 3010	4220 3012
4220 4008	4220 4010	4220 4012

COMO C FOR I-0-II OPERATION

CATALOG NUMBER: 3 POLE
CATALOG NUMBER: 4 POLE

4230 3008	4230 3010	4230 3012
4230 4008	4230 4010	4230 4012

COMO C FOR I-0-II BY-PASS OPERATION

CATALOG NUMBER: 3 + 6 POLE
CATALOG NUMBER: 4 + 8 POLE

4250 3008	4250 3010	4250 3012
4250 4008	4250 4010	4250 4012

COMO C FOR I-I+II-II OPERATION (OVERLAPPING)

CATALOG NUMBER: 3 POLE
CATALOG NUMBER: 4 POLE

4240 3008	4240 3010	4240 3012
4240 4008	4240 4010	4240 4012



SELECT A SWITCH

COMO C FOR I-0-II OPERATION WITH ONE AUXILIARY CONTACT

CATALOG NUMBER: 3 POLE
CATALOG NUMBER: 4 POLE

4230 3108	—	—
4230 4108	—	—

COMO C FOR I-0-II OPERATION WITH TWO AUXILIARY CONTACTS

CATALOG NUMBER: 3 POLE
CATALOG NUMBER: 4 POLE

4230 3208	—	—
4230 4208	—	—

EXTERNAL AND DIRECT OPERATION



SELECT A HANDLE

TO SUIT SWITCH	PADLOCK POSITION	IP RATING	COLOR	CATALOG NUMBER		
I-II	I-II	IP54	Black/Grey	4259 1082	4259 1082	4259 1082
I-II	I-II	IP54	Red/Yellow	4259 1083	4259 1083	4259 1083
I-0-II / By-pass	0	IP54	Black/Grey	4259 1082	4259 1082	4259 1082
I-0-II / By-pass	0	IP54	Red/Yellow	4259 1083	4259 1083	4259 1083
I-I+II-II	I-I+II-II	IP54	Black/Grey	4259 1082	4259 1082	4259 1082
I-I+II-II	I-I+II-II	IP54	Red/Yellow	4259 1083	4259 1083	4259 1083
I-II	—	IP54	White	4259 2082	4259 2082	4259 2082
I-0-II / By-pass	—	IP54	White	4259 3082	4259 3082	4259 3082
I-I+II-II	—	IP54	White	4259 4082	4259 4082	4259 4082

FOR EXTERNAL OPERATION ONLY



SELECT A SHAFT

SHAFT LENGTH (inches/mm)	CATALOG NUMBER		
7.9/200	4259 5082 ⁽¹⁾	4259 5082 ⁽¹⁾	4259 5082 ⁽¹⁾



OPTIONS FOR I-II / I-0-II / BY-PASS / I-I+II-II CHANGEOVER SWITCHES

	CATALOG NUMBER		
Back plate mounting device	4259 9080	4259 9080	4259 9080
DIN rail mounting device	4259 9001	4259 9001	4259 9001

(1) Includes an escutcheon allowing the function of door interlocking in ON position

K

COMO C

MANUALLY OPERATED CHANGEOVER SWITCHES FROM 25 TO 125 A

COMO C ELECTRICAL & MECHANICAL CHARACTERISTICS

UL AND cUL TECHNICAL CHARACTERISTICS

Rating		25	40	63	80	100	125
UL approval		UL 508 Manual Motor Controller					
Short circuit current rating w/fuses	kA	5	5	5	5	5	5
Branch circuit fuse type		J	J	K5	K5	K5	K5
Max fuse rating	A	70	125	80	100	125	150
Maximum UL Horsepower ratings (3-PH)		HP					
200/208 V AC		1.5	5	15	15	20	20
220/240 V AC		2	7.5	15	20	25	25
380/415 V AC		3	10	25	25	30	30
440/480 V AC		5	15	30	30	40	40
550/600 V AC		7.5	20	32	40	50	50
Maximum UL Horsepower ratings (1-PH)		HP					
110/120 V AC		2	2	5	7.5	10	10
220/240 V AC		5	5	10	15	15	15
Terminal lugs							
Max wire size	AWG	10	6	1	1	1	1
Wire type		Cu	Cu	Cu	Cu	Cu	Cu
Minimum wire tightening torque	lb.in.	14.2	16.0	21.3	21.3	21.3	21.3
Weight (lb/kg)							
3-pole changeover switch with direct handle		0.55/0.25	0.66/0.30	1.21/0.55	1.39/0.63	1.39/0.63	1.39/0.63
4-pole changeover switch with direct handle		0.68/0.31	0.88/0.40	1.54/0.70	1.76/0.80	1.76/0.80	1.76/0.80

IEC 947-3 TECHNICAL CHARACTERISTICS

Rating (Thermal current Ith at 40°C)	A	25	40	63	80	100	125
Rated insulation voltage Ui (V)		660	660	660	660	660	660
Rated impulse withstand voltage Uimp (kV)		4	4	4	4	4	4
Rated operating current Ie (A)							
400 V AC	AC 21A	25	40	63	80	100	125
	AC 22A	25	40	63	80	100	100
	AC 23A	20	32	63	63	63	85
500 V AC	AC 21A	25	40	63	80	100	125
	AC 22A	25	40	63	63	100	100
	AC 23A	20	25	50	50	63	85
Motor Power (kW)							
400 V AC without pre break auxiliary contact:	AC 23	10	15	20	26	32	32
500 V AC without pre break auxiliary contact:	AC 23	12	18.5	22	30	36	36
Overcurrent capacity							
Fuse-protected short circuit withstand (kA rms prospective) with gG DIN fuse ⁽¹⁾		6	6	15	15	15	15
Rating of DIN gG fuse (A)		25	40	63	80	100	125
Cut-off current (kA peak) ⁽¹⁾		2	2.6	5.8	5.8	5.8	5.8
Mechanical durability (number of operations)		100 000	100 000	100 000	100 000	100 000	100 000
Connection (copper)							
Minimum section at Ith (cable)	mm ²	2.5	6	10	16	16	16
Maximum section (cable)	mm ²	6	16	50	50	50	50
Minimum tightening torque	Nm	1.6	1.8	2.4	2.4	2.4	2.4

(1) For a rated operating voltage Ue=400 V AC

COMO C

MANUALLY OPERATED CHANGEOVER SWITCHES

DIMENSIONS (dual dimensions: in/mm)

COMO C - 25 A

Door mounted with direct operation

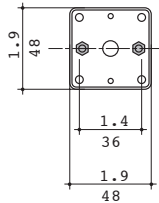
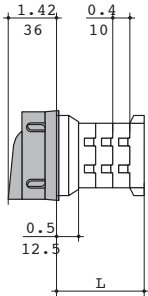

Back mounted with direct operation

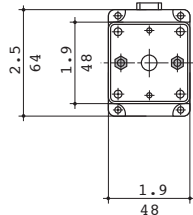
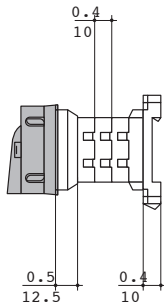

Back mounted with external operation

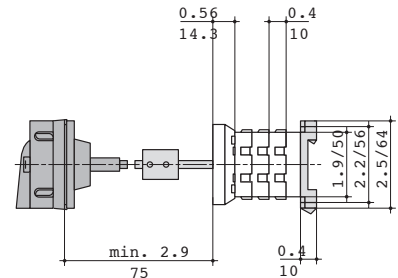

25 A	I - 0 - II		I - II		I - I + II - II		I - 0 - II BY-PASS	
COMO C	3 P	4 P	3 P	4 P	3 P	4 P	3 + 6 P	4 + 8 P
L	1.99/50.5	2.38/60.5	1.99/50.5	2.38/60.5	1.99/50.5	2.38/60.5	2.77/70.5	3.17/80.5

COMO C - 40 A

Door mounted with direct operation

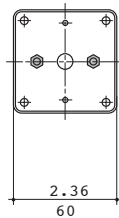
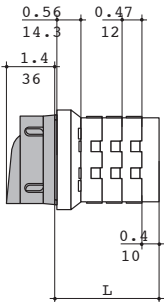

Back mounted with direct operation

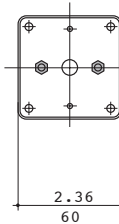
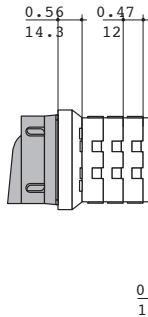

Back mounted with external operation

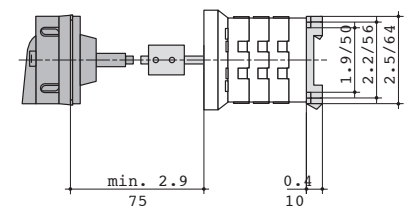

40 A	I - 0 - II		I - II		I - I + II - II		I - 0 - II BY-PASS	
COMO C	3 P	4 P	3 P	4 P	3 P	4 P	3 + 6 P	4 + 8 P
L	2.37/60.3	2.85/72.3	2.37/60.3	2.85/72.3	2.37/60.3	2.85/72.3	3.32/84.3	3.79/96.3

COMO C - 63 - 80 - 100 - 125 A

Door mounted with direct operation

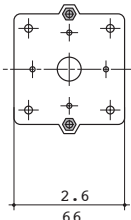
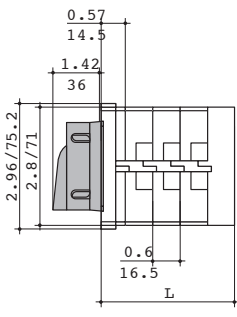

Back mounted with direct operation

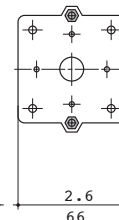
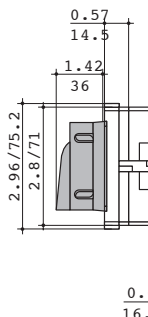

Back mounted with external operation

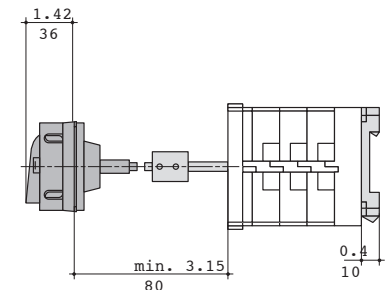

63 A - 80 A - 100 A - 125 A	I - 0 - II		I - II		I - I + II - II		I - 0 - II BY-PASS	
COMO C	3 P	4 P	3 P	4 P	3 P	4 P	3 + 6 P	4 + 8 P
L	3.15/80	3.82/97	3.15/80	3.82/97	3.15/80	3.82/97	4.48/113.8	5.14/130.5



COMO C

MANUALLY OPERATED CHANGEOVER SWITCHES

DOOR DRILLING (DUAL DIMENSIONS: IN/MM)

Back mounted with direct operation

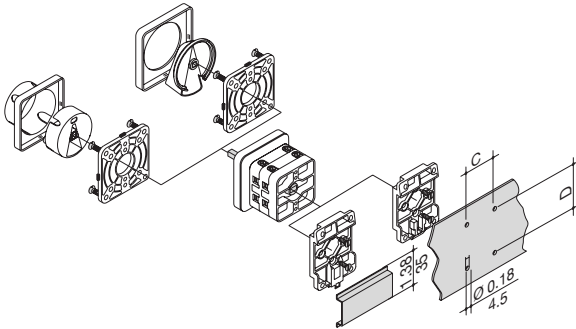

Door mounted with direct operation

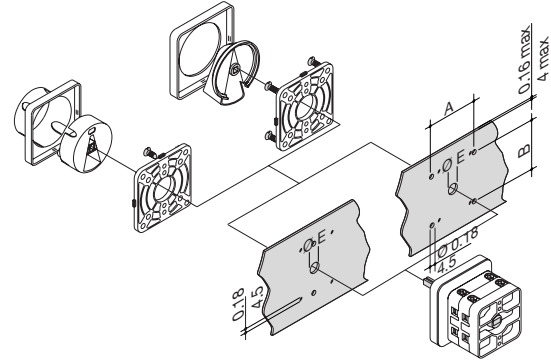

Back mounted with external operation

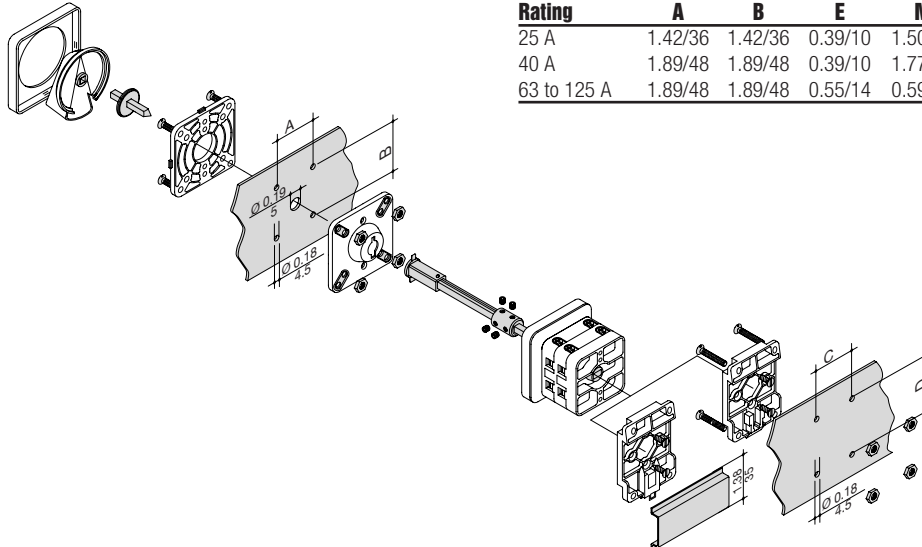

Rating	A	B	E	M	C	D
25 A	1.42/36	1.42/36	0.39/10	1.50/38	1.42/36	2.20/56
40 A	1.89/48	1.89/48	0.39/10	1.77/45	1.42/36	2.20/56
63 to 125 A	1.89/48	1.89/48	0.55/14	0.59/15	3.07/78	3.07/78

AUXILIARY CONTACTS DIMENSIONS

One aux. contact

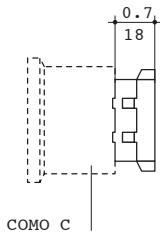

Two aux. contacts

